

BOYAMA

Güven
Usta

Okul öncesi

KITABI



ÇSGB

T.C. ÇALIŞMA VE SOSYAL GÜVENLİK BAKANLIĞI
İŞ SAĞLIĞI VE GÜVENLİĞİ GENEL MÜDÜRLÜĞÜ





Güvenlik Eldiveni

Çalışırken ellerimiz zarar görmesin diye iş eldiveni giymeliyiz

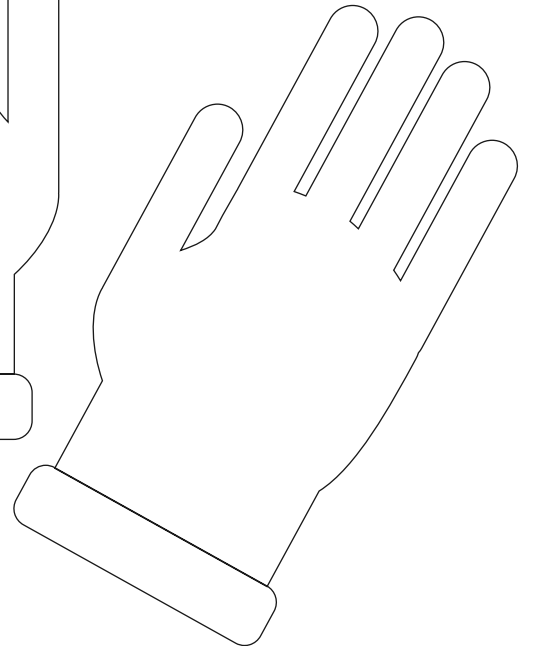
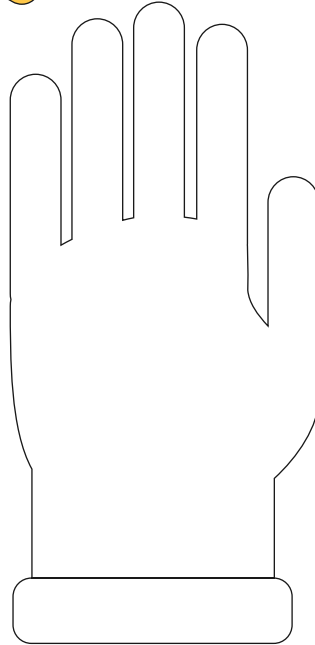
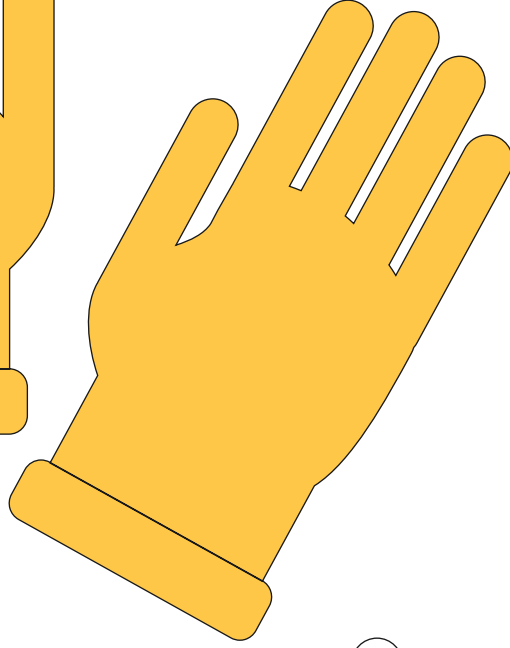
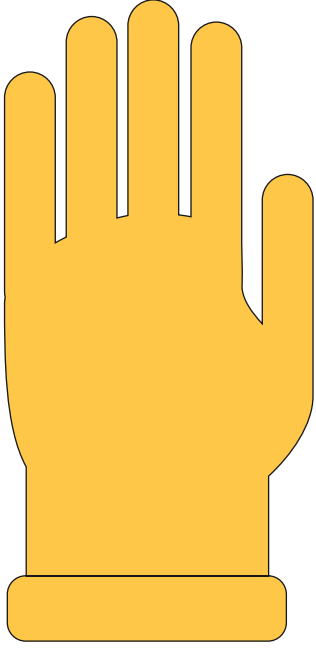

Gaz Maskesi

*Tehlikeli gaz sızıntıları olduđunda
nefes alabilmemiz iin gaz maskesi kullanmalıyız*

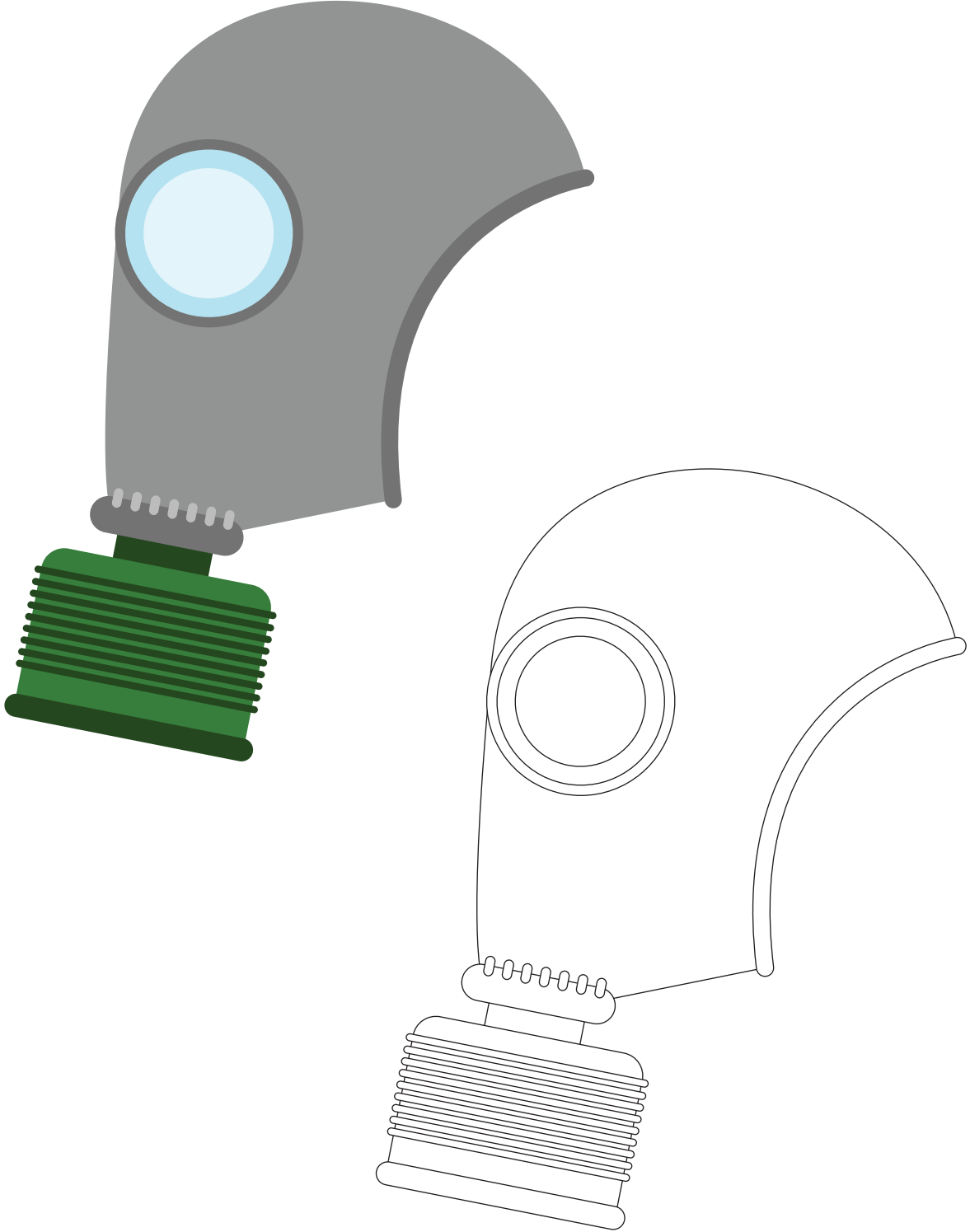

Yangın Tüpü

Yangın tehlikesine karşı yaşadığımız ortamlarda mutlaka yangın tüpü bulundurmamız gerekir

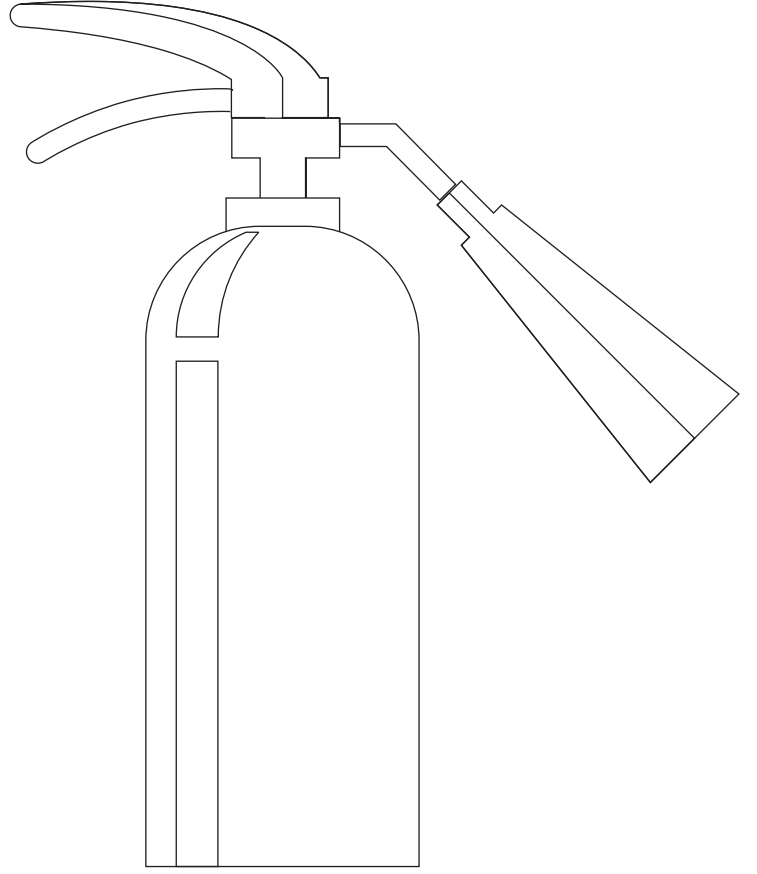

Koruyucu Baret

*İnşaat gibi tehlikeli alanlarda
başımızı korumak için mutlaka koruyucu baret
kullanmalıyız*



Güvenlik Gözlüğü

Çalışırken gözümüzü zararlı maddelerden korumak için güvenlik gözlüğü kullanmalıyız

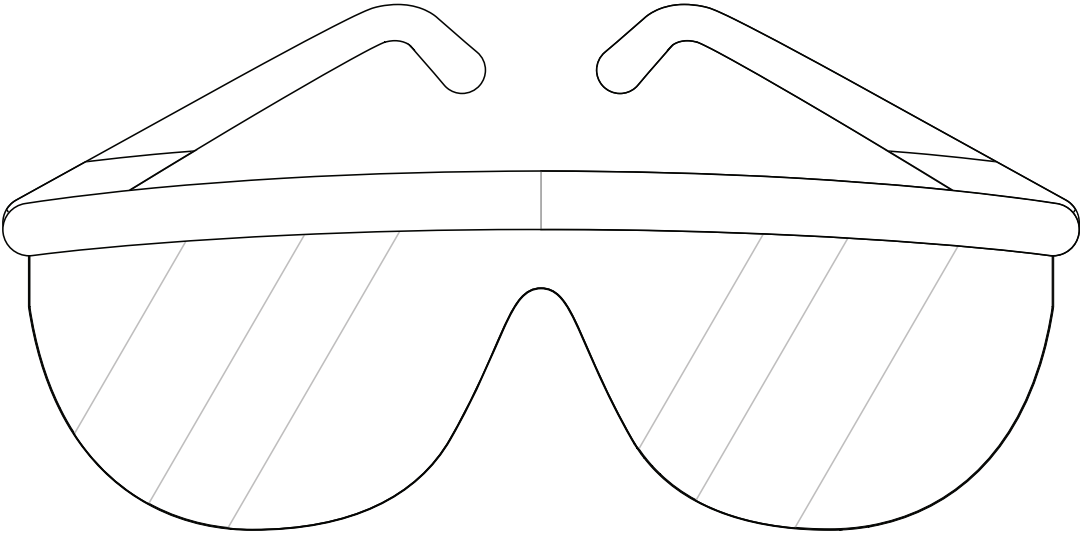

Merdiven

Evimizde veya iş yerimizde ulaşamayacağımız yüksekliklere çıkmak için mutlaka sağlam bir merdiven kullanmalıyız

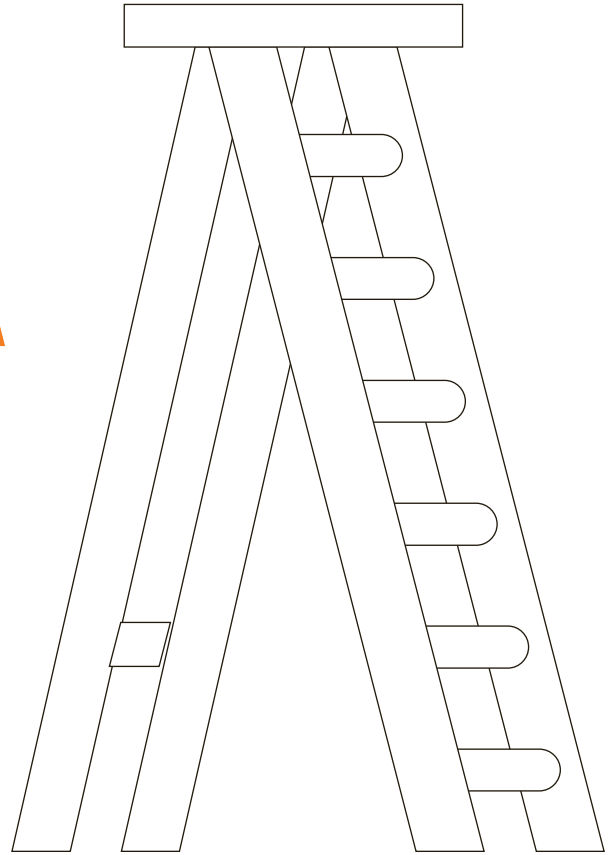
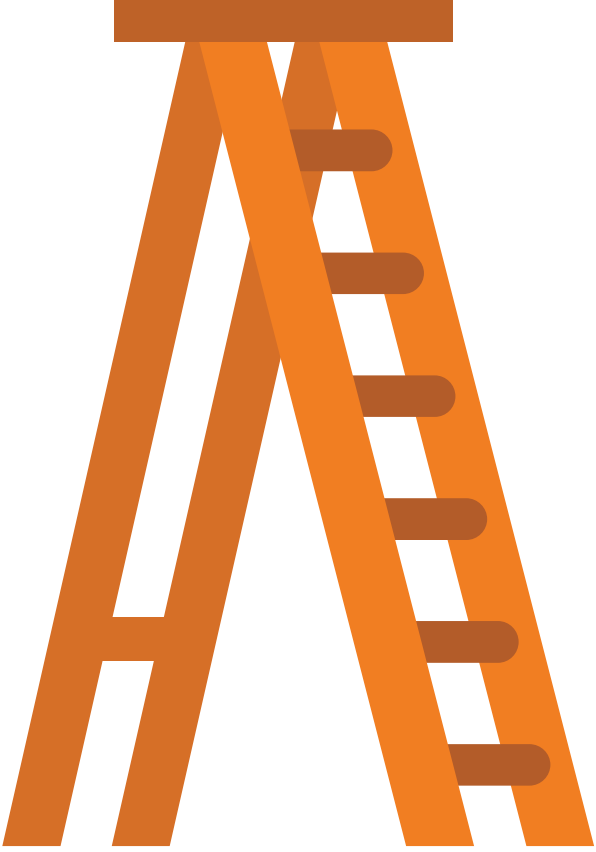

Güvenlik Yeleđi

Çalıřırken ışığın az olduđu ortamlarda
fark edilmek için güvenlik yeleđi giymeliyiz

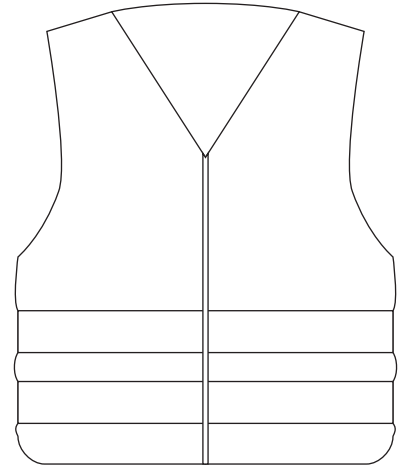
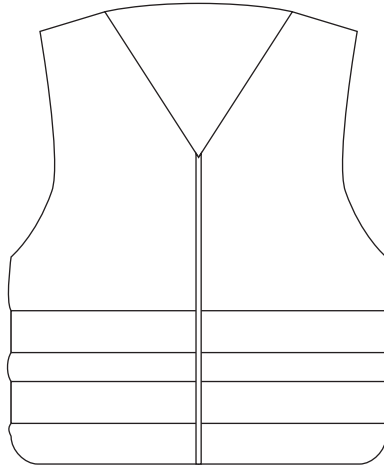
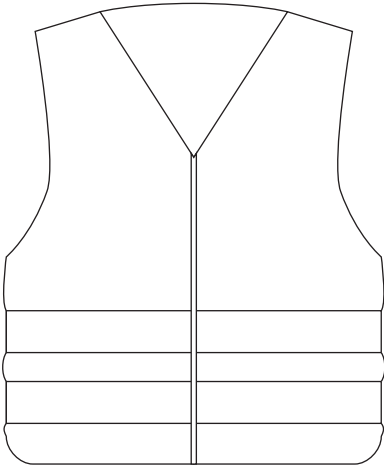
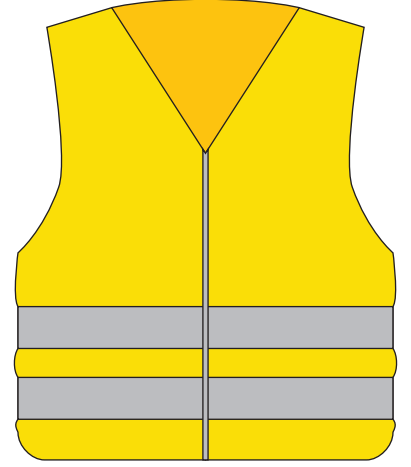
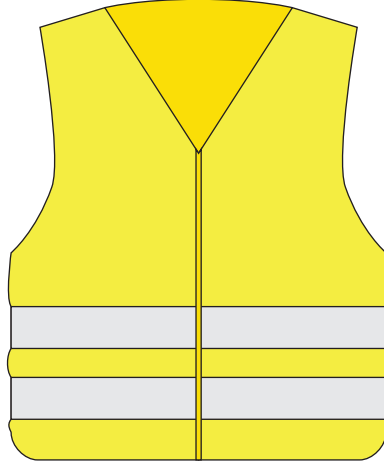
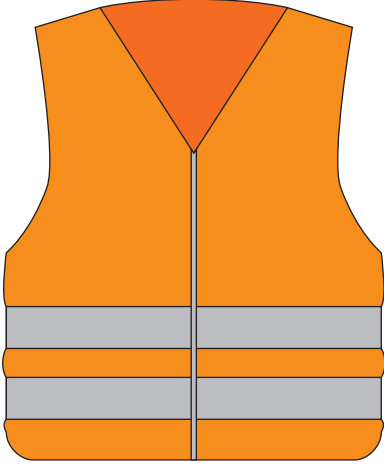

Kaygan Zemin Levhası

Kayma tehlikesi olan alanlarda mutlaka uyarı levhası kullanmalıyız



Trafik Lambası

Trafikte; kırmızı ıřıkta durmalı,
sarı ıřıkta harekete hazır olmalı ve
yeřil ıřıktada gemeliyiz

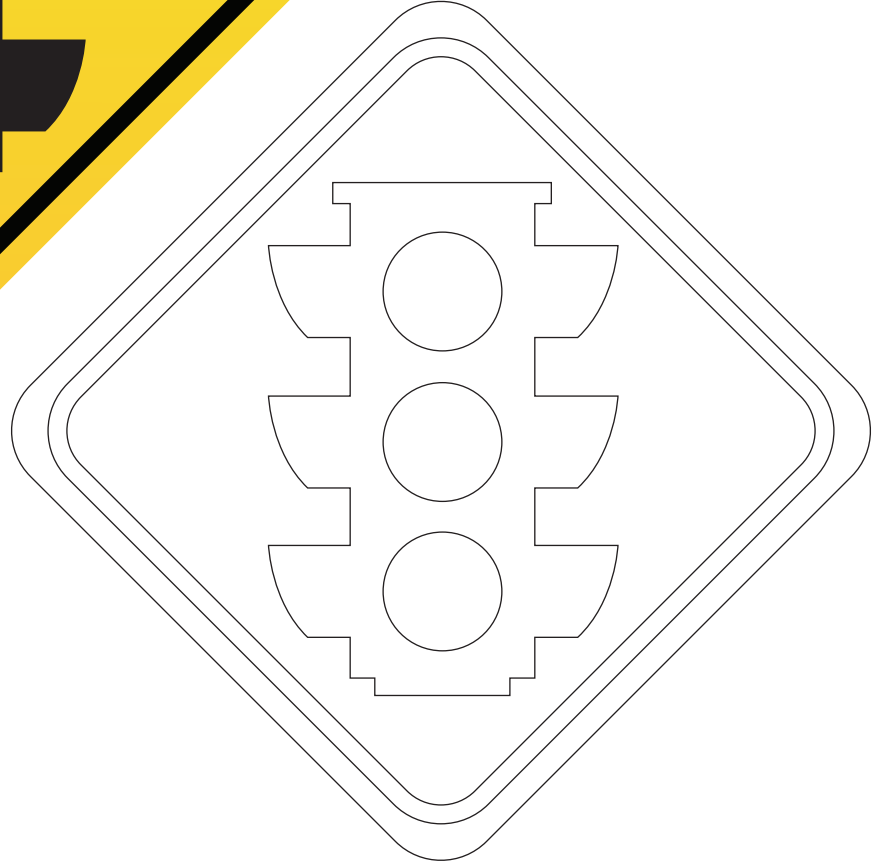
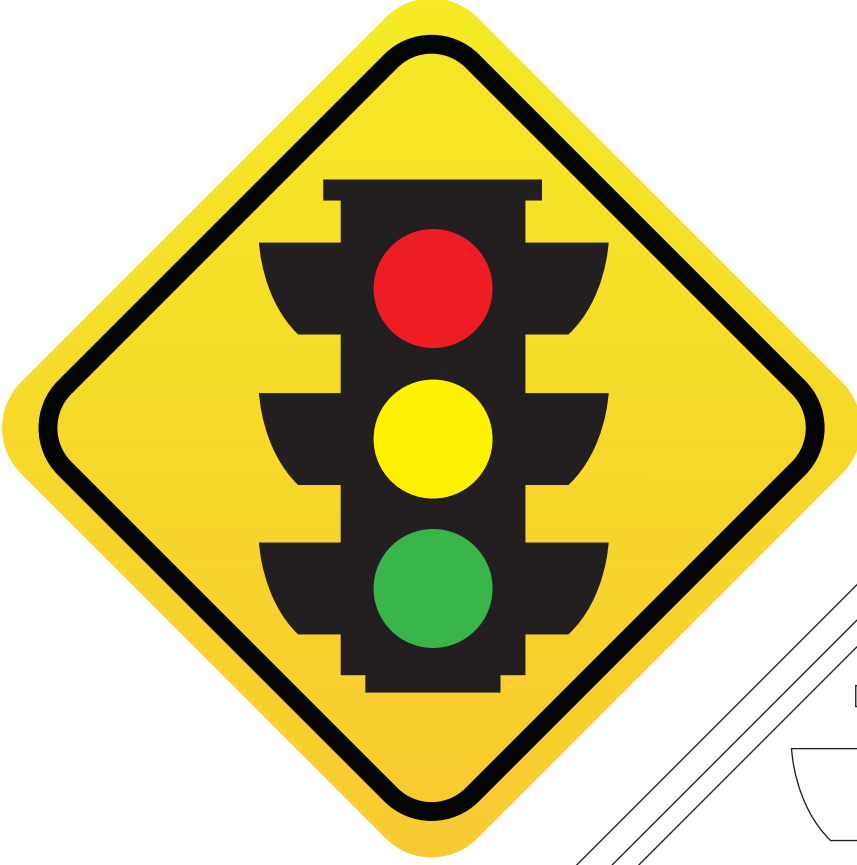

Kazı Çalışması

Çalışma alanlarındaki
ikaz levhalarına dikkat etmeliyiz

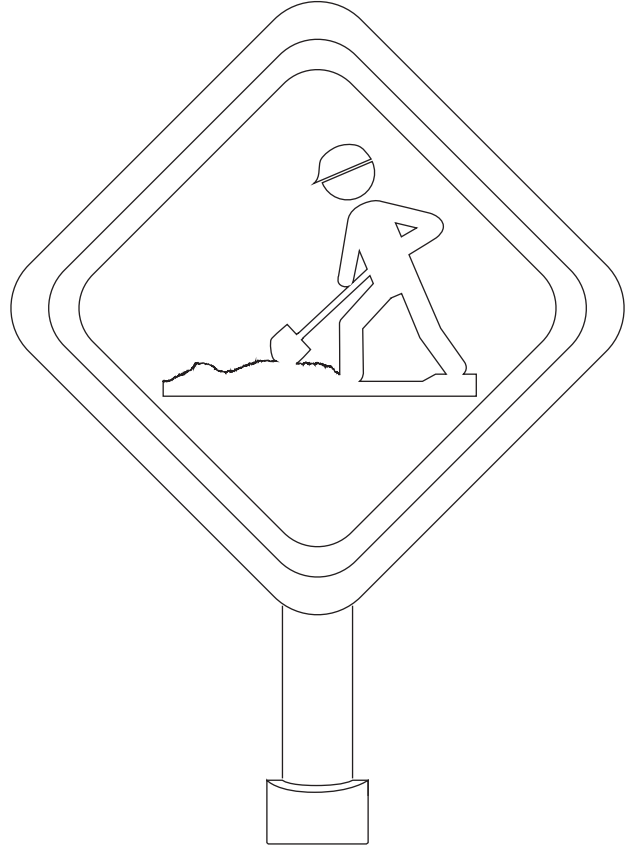

Emniyet Kemerini

Araç içinde mutlaka emniyet kemerini takmalıyız



Yangın Alarmı

Yangın anında yangın alarmına basıp
etrafımızdakileri uyarmalıyız

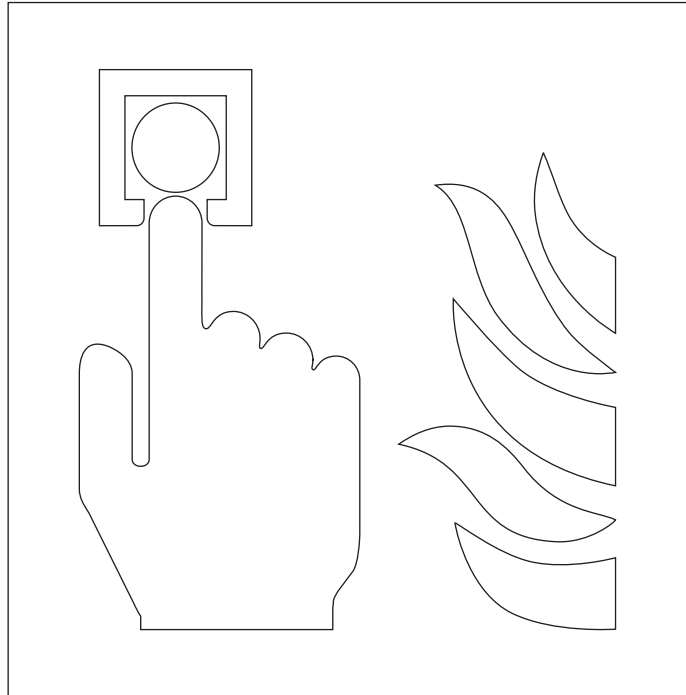

*Sandalyede kambur pozisyonda oturmak
vücudumuza ciddi zararlar verir*



*Hatalı olan oturma şeklini kırmızı,
doğru olan oturma şeklini yeşile boyayın*

*Sandalyede otururken mutlaka
dik pozisyonda oturmalıyız*

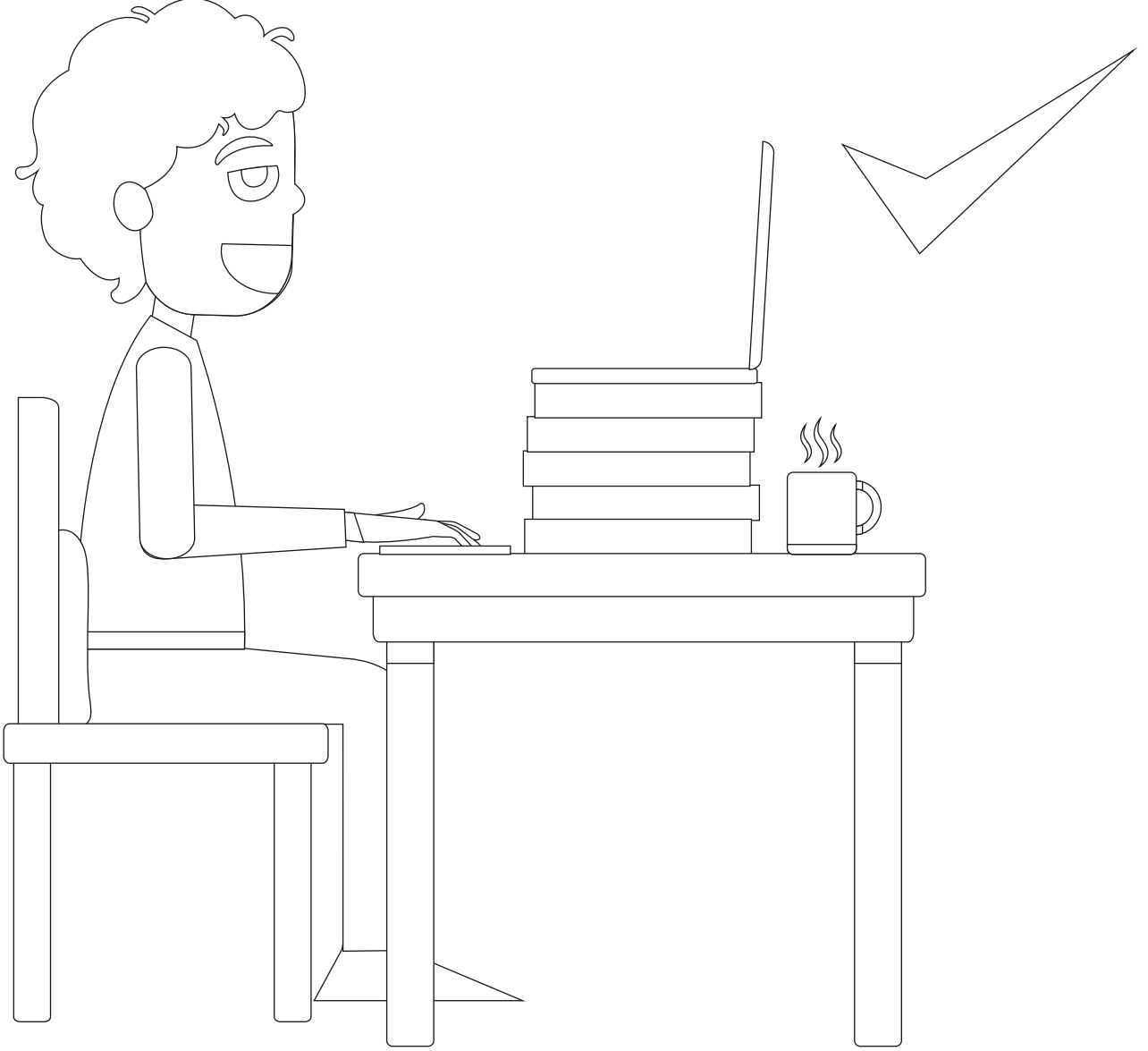

Ecza Dolabı

İlaçlar mutlaka ecza dolabında saklanmalıdır

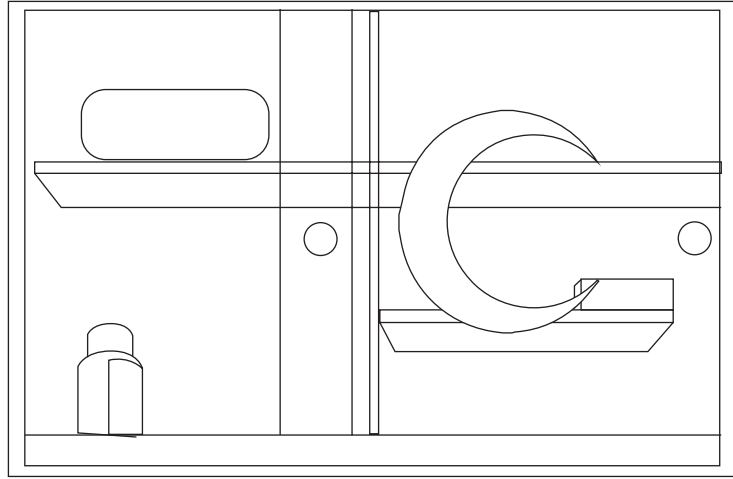
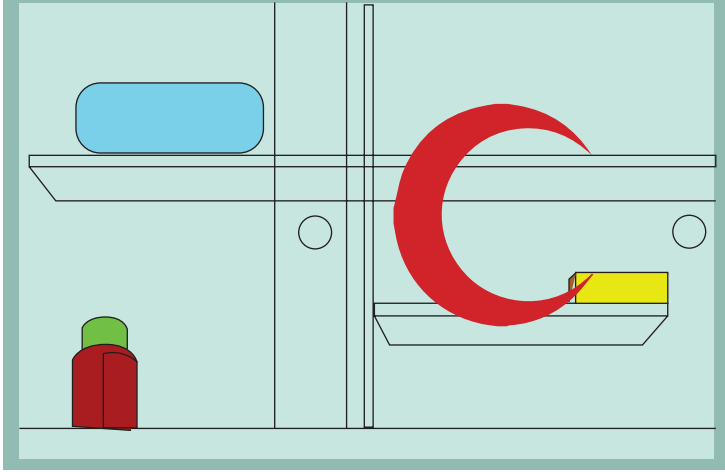

Tehlikeli işlerde çalışırken mutlaka güvenli
kıyafetler giymeliyiz

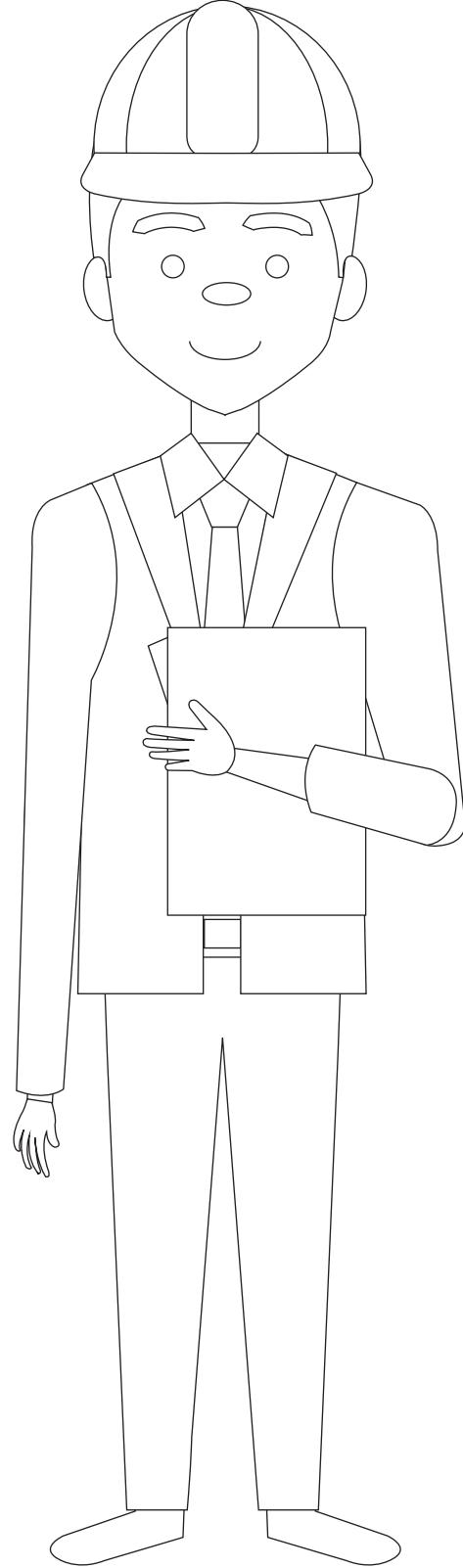
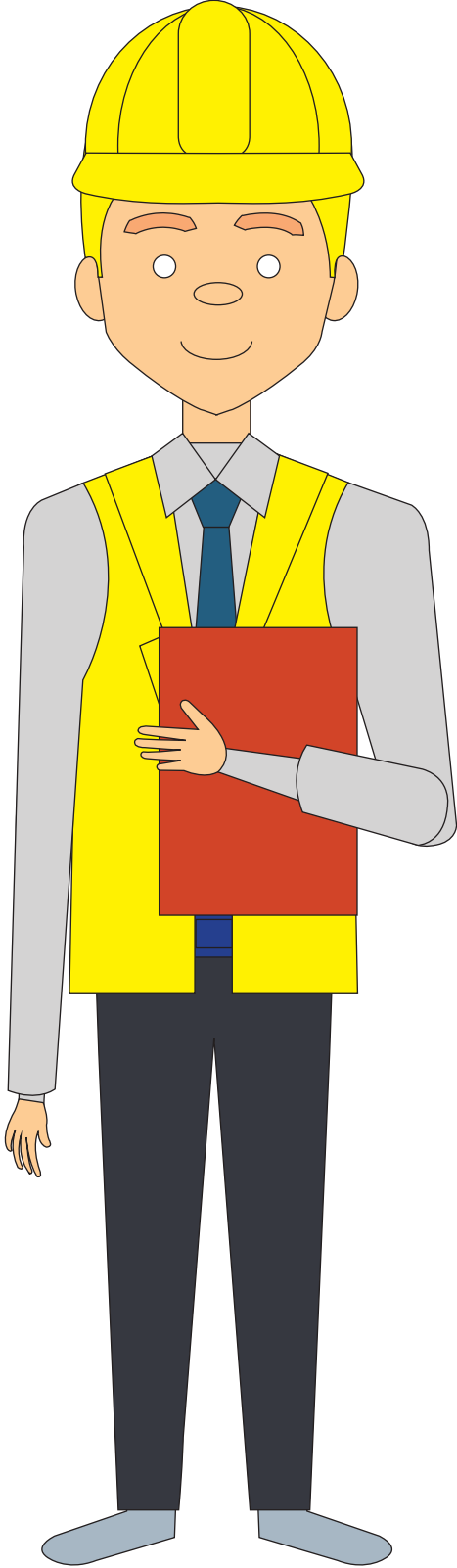

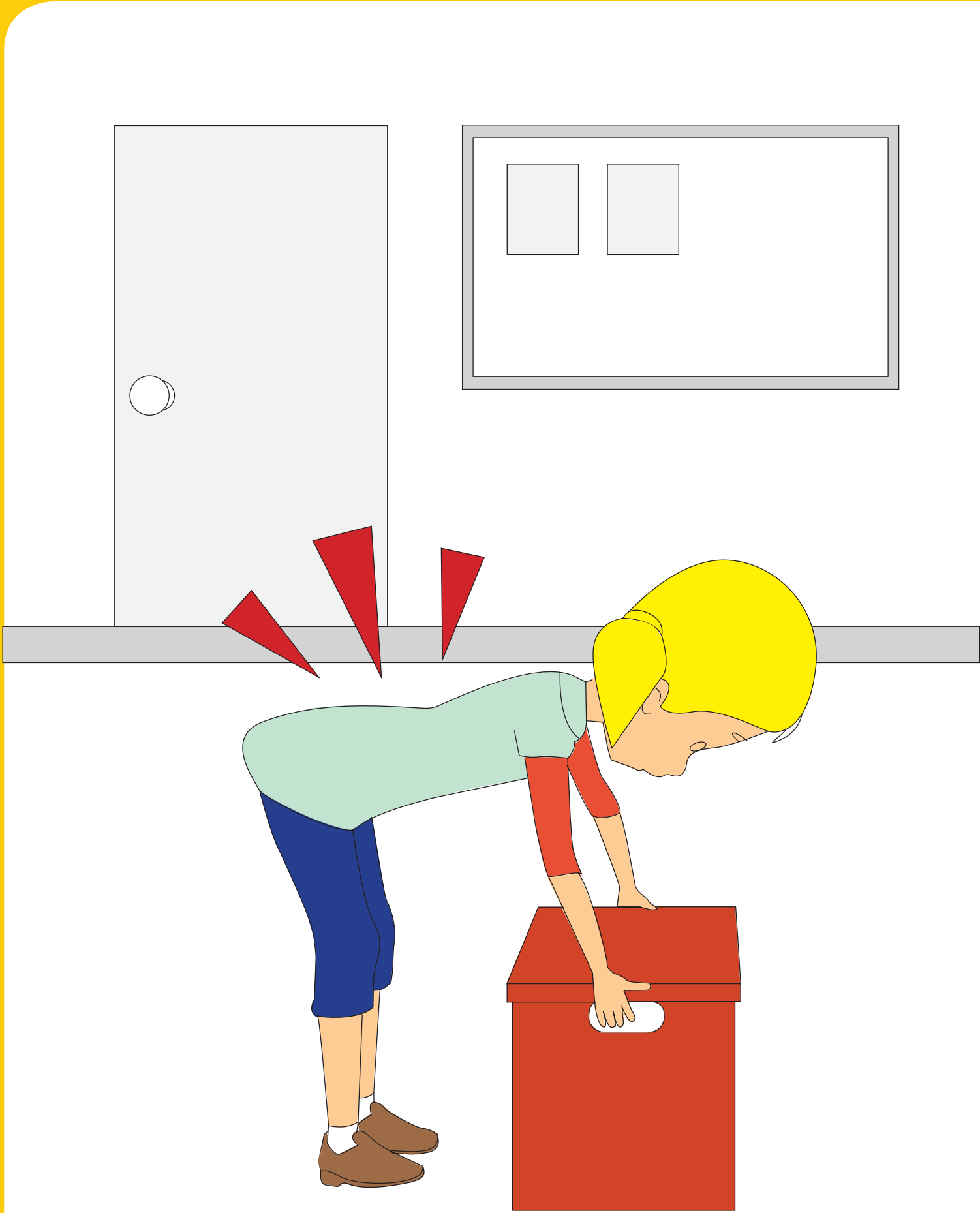

Ađır eřyalari kaldırmamalıyız

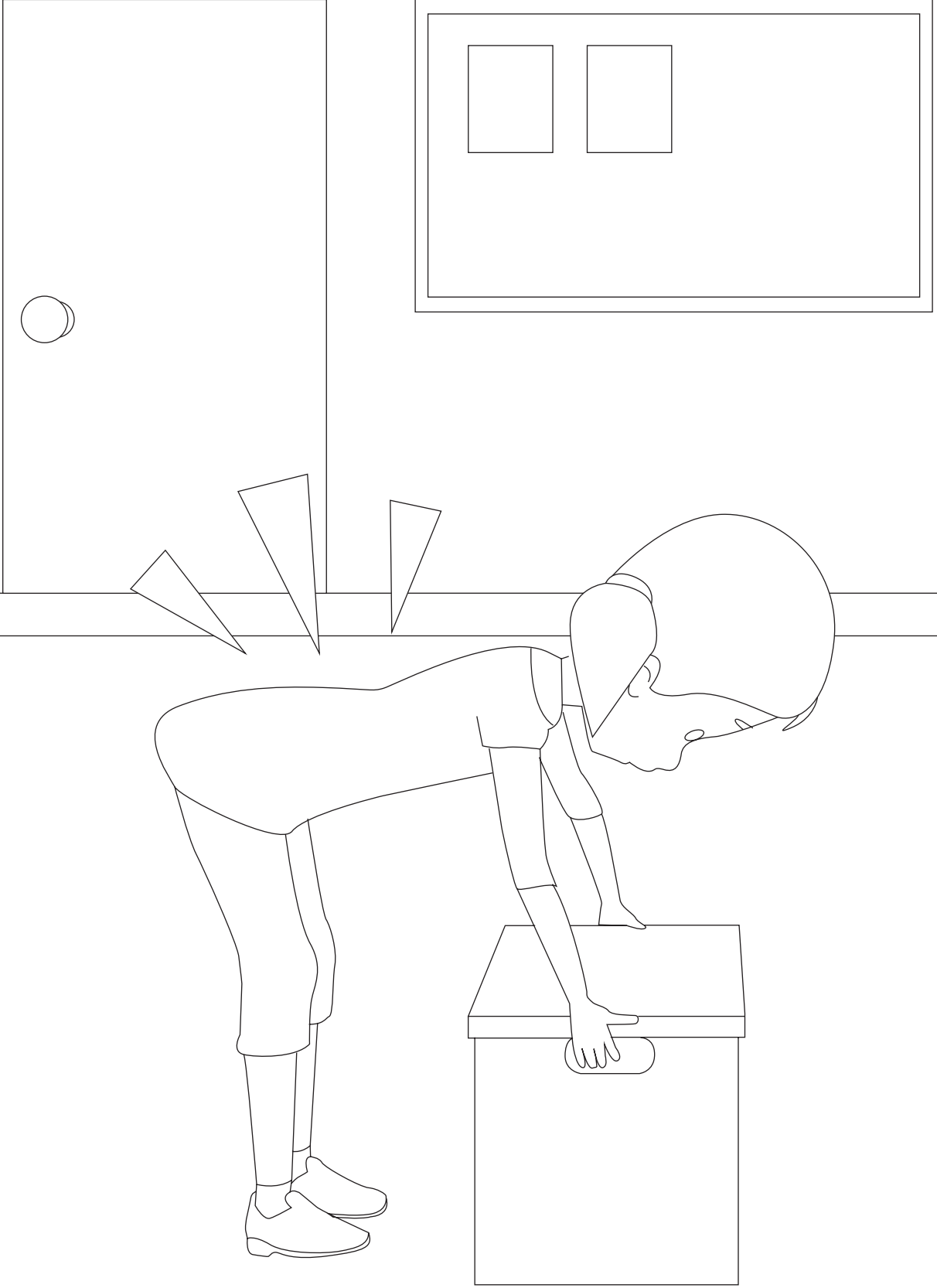

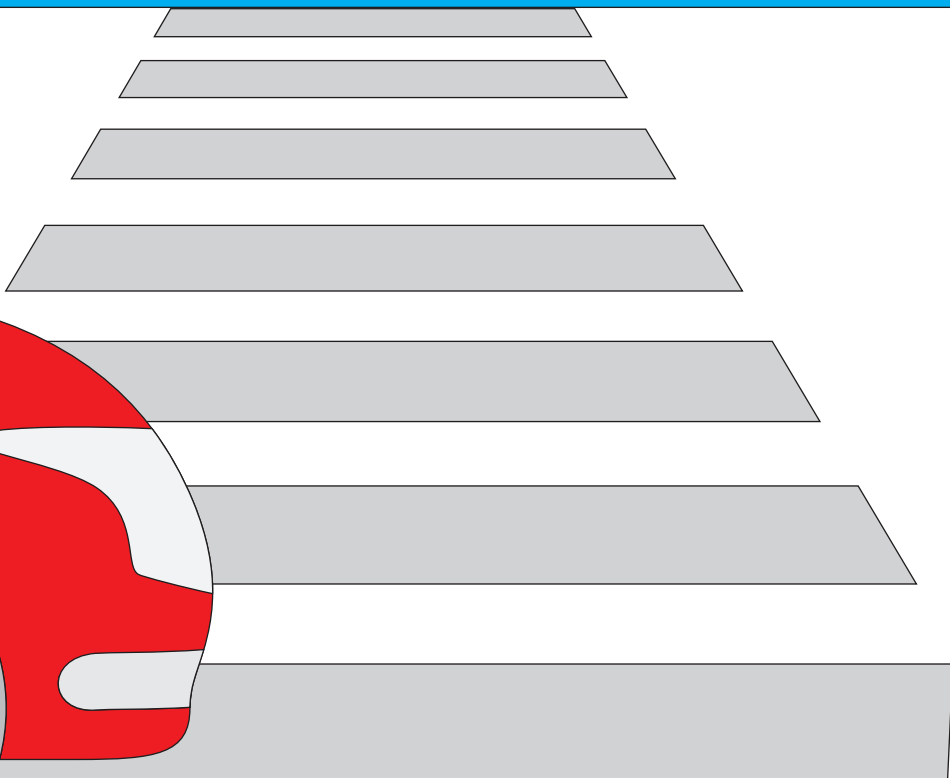
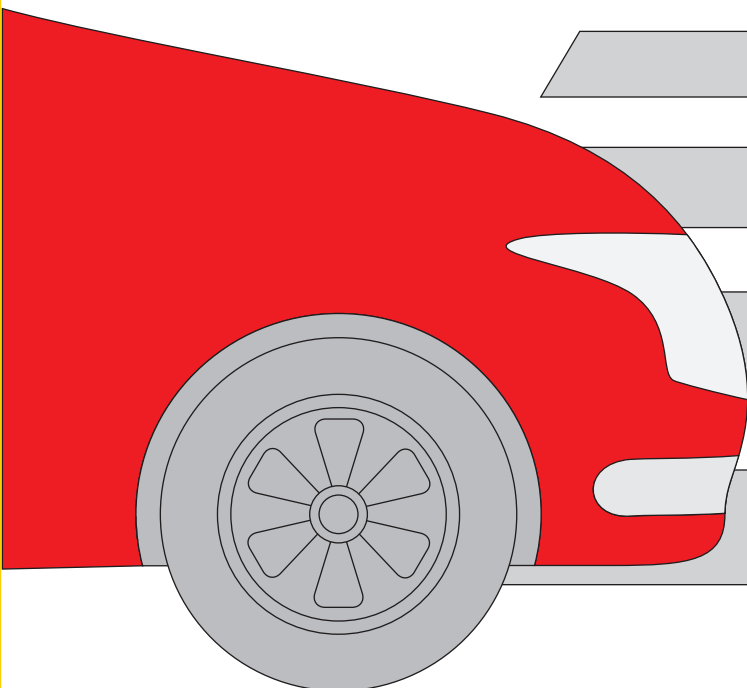
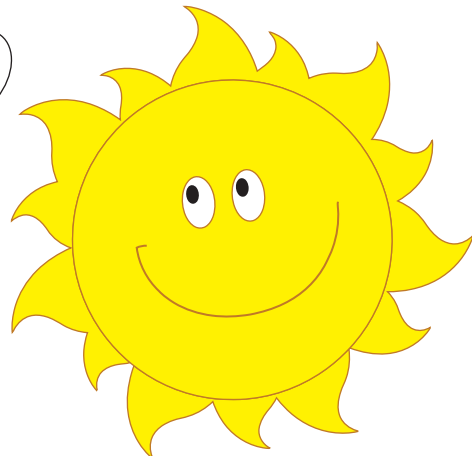
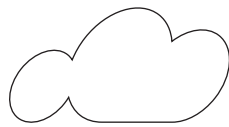
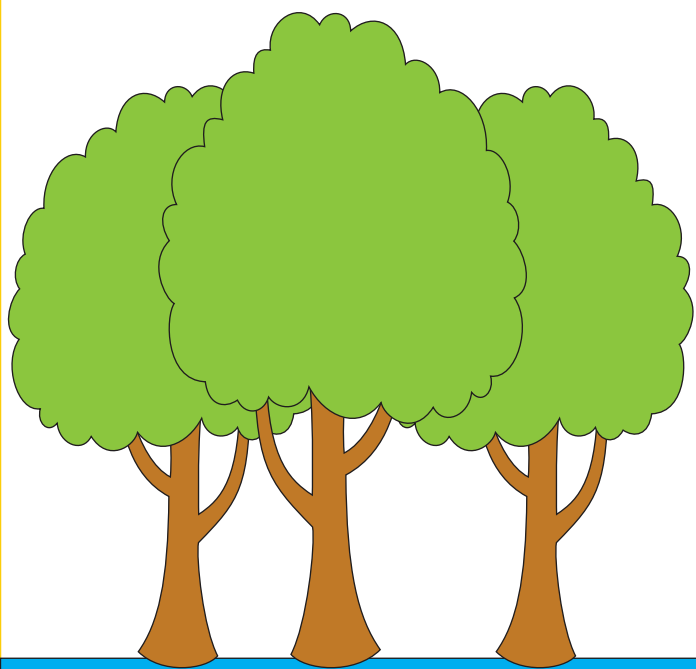

Karşıdan karşıya geçerken yaya geçidini kullanmalıyız

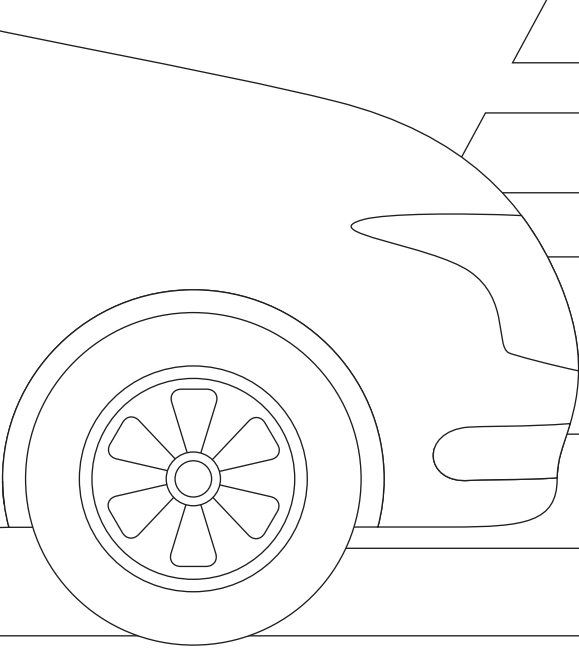
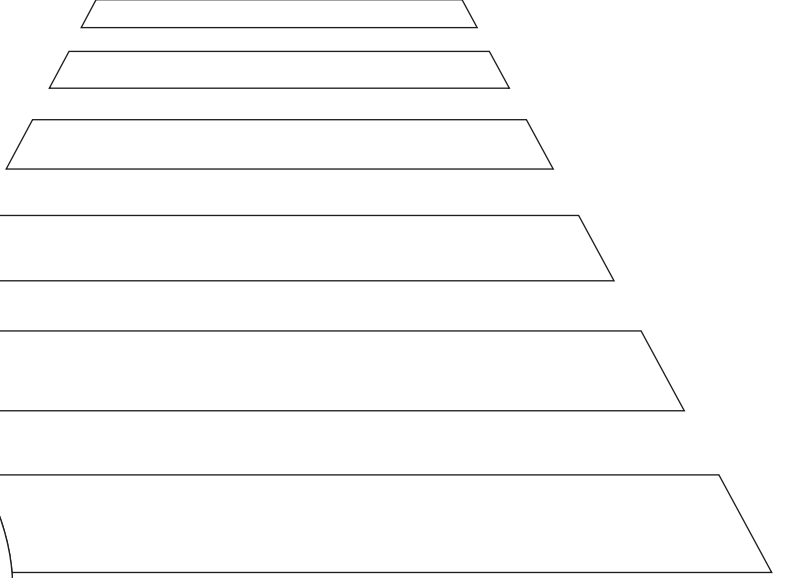
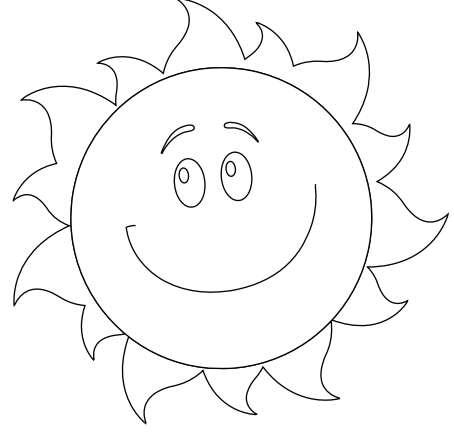
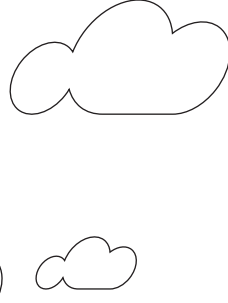
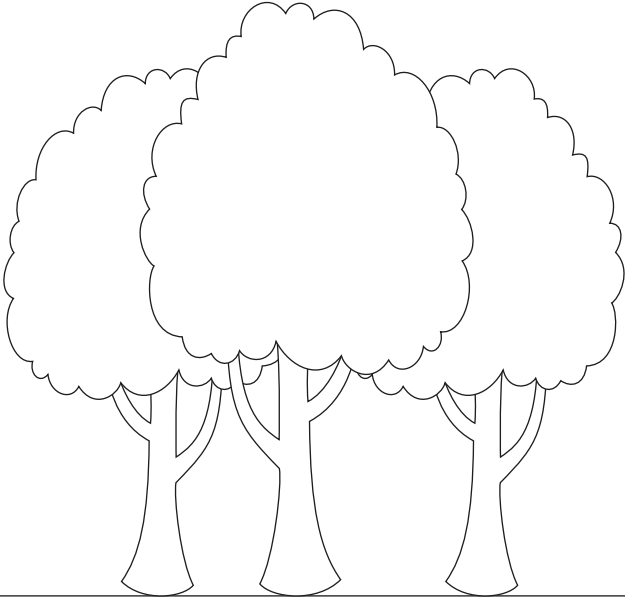

BOYAMA

Güven
Usta

Okul öncesi

KITABI

